

Lateral Approach - Sinus KIT **LAS-KIT / LAS-KIT Plus**

Lateral Approach - Sinus KIT

**LAS-KIT / LAS-KIT Plus**

Edition 07 / 2014

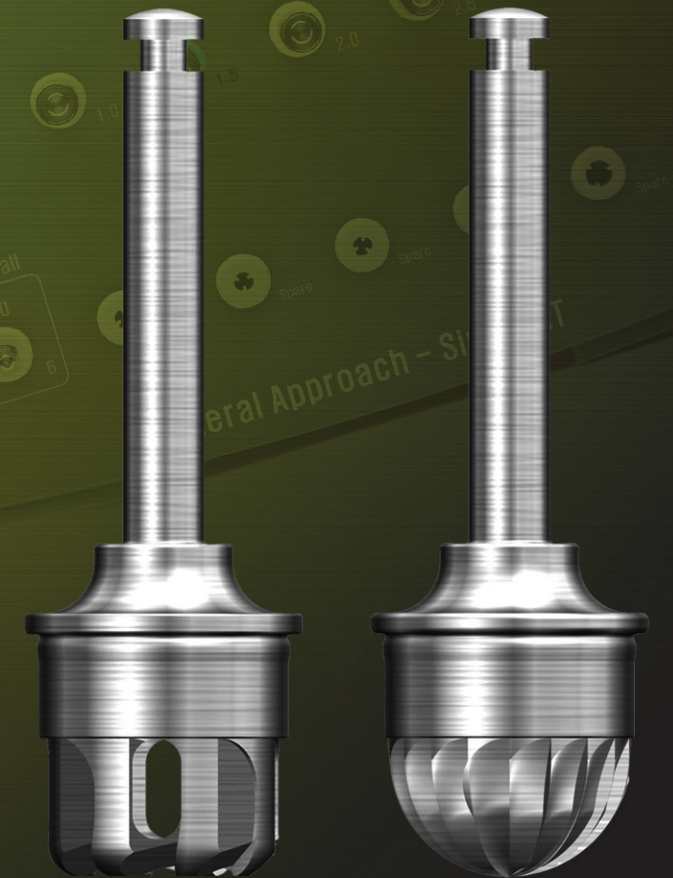

# LAS-KIT / LAS-KIT Plus

(Lateral Approach - Sinus KIT)

## Contents

- 1) Introduction
- 2) Features
- 3) Components
- 4) Clinical indication and Case
- 5) Instruction for Use

## Introduction

Hiossen's Lateral Approach Sinus Kit is specifically designed for a fast and safe lateral approach to lift sinus membrane.

LAS-KIT offers various usage depending on the oral anatomy and surgical plans.

LAS-KIT contains Dome drill to create a lateral window, Wide dome drill to widen the window, Core drill that can create core bone lid.

- Dome and Core Drills to create lateral window.
- Stopper system to prevent excessive and over drilling.
- Dome Drill - Exceptional cutting ability through the combined use of macro and micro blades.
- Core Drill - continued successful design concept of CAS Drills
- Wide dome drill and side wall drill to enlarge the window

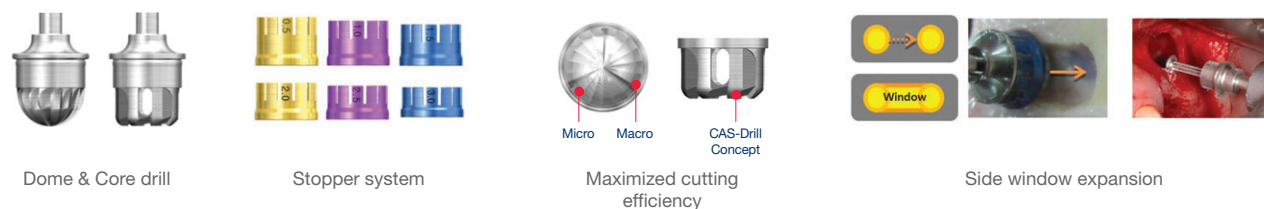

## LAS-KIT / LAS-KIT Plus (Lateral Approach - Sinus KIT)

Hiossen's Lateral Approach Sinus Kit is specifically designed for a fast and safe approach to lateral sinus lifts.

## Features

• Dome and Core Drills provide ideal approaches to the opening of the lateral wall.



• Excellent cutting ability of the Dome and Core Drills

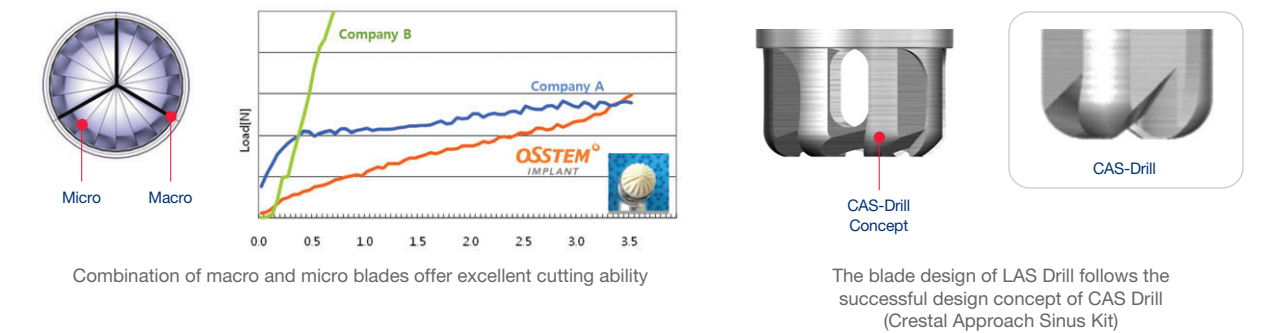

• Wide Dome Drill and Side Wall Drill used to enlarge the window



• Widen the window with Side Wall Drill



• Hiossen's unique stopper system for depth control.  
(a total of 6 stoppers : 0.5 / 1.0 / 1.5 / 2.0 / 2.5 / 3.0mm)



LAS-KIT comes with Dome Drill and Core Drill that provide various approaches to a fast and safe lift of sinus membrane.

### Safe Elevation of Sinus Membrane

#### <Dome drill>

- Minimizing direct contact with the membrane by forming a bone lid

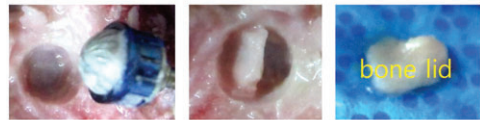

- Formation of bone particles between the cutting blades



- Effective depth control by stopper system (0.5mm increment)
- Stopper can prevent soft tissue damage



#### <Core drill>

- Round-shaped cutting edge minimizes direct contact with the membrane

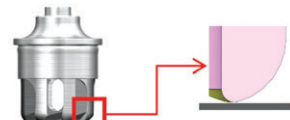

- Formation of bone particles between the cutting blades



- Effective depth control by stopper system (0.5mm increment)
- Stopper can prevent soft tissue damage



### Ease of Use

#### <Dome drill>

- The blade head can be perpendicular to the bone to perform an osteotomy.



- For limited space at surgical site, Dome Drill can be tilted to drill.

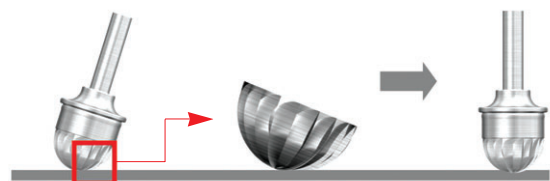

#### <Core drill>

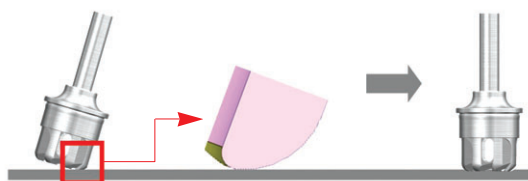

## LAS-KIT (HLRSNK)

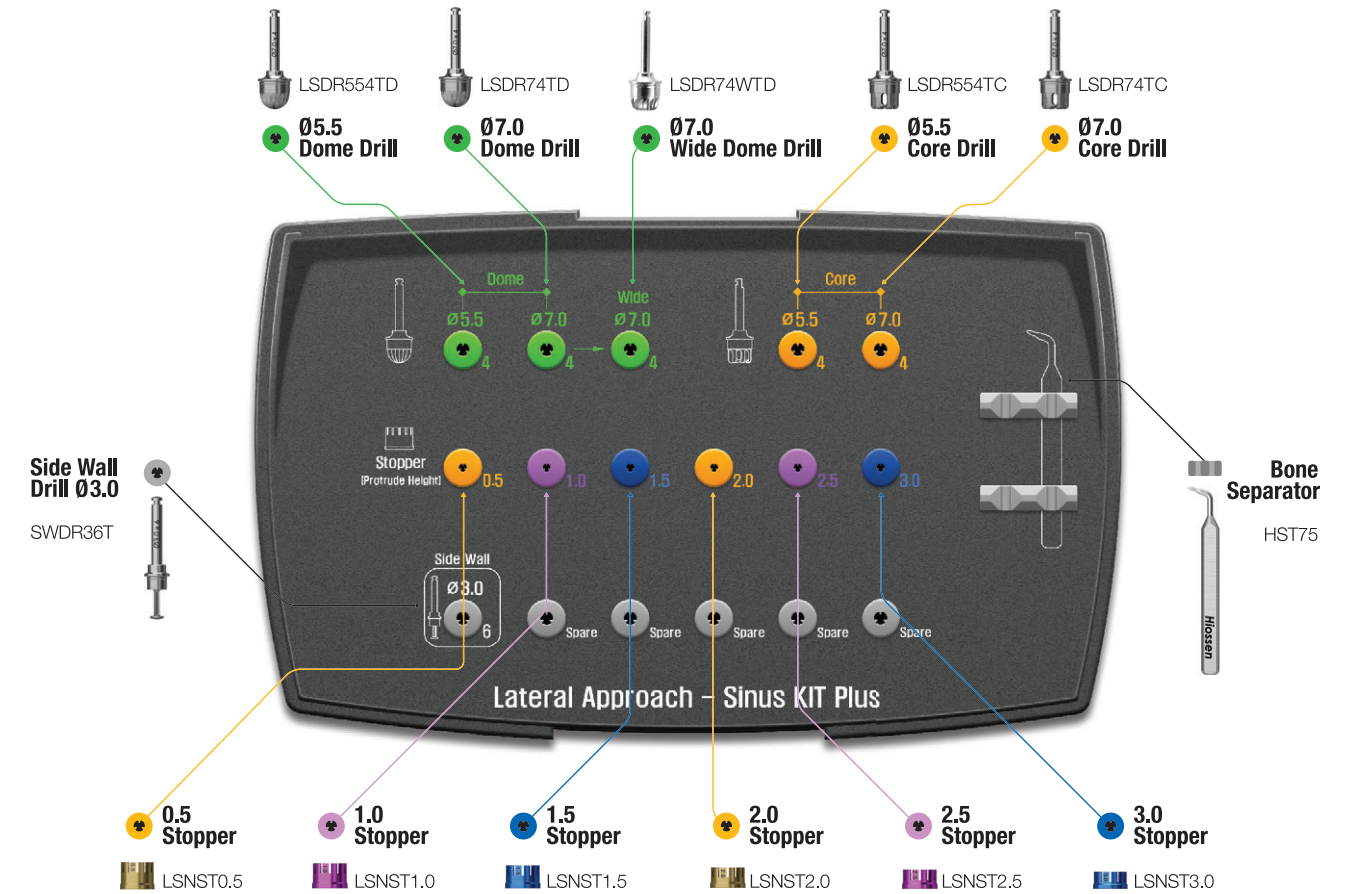

## LAS-KIT Plus (HLRSNKP)

- LAS-KIT Plus has 5 additional surgical tools inside a lower-plate of the LAS-KIT

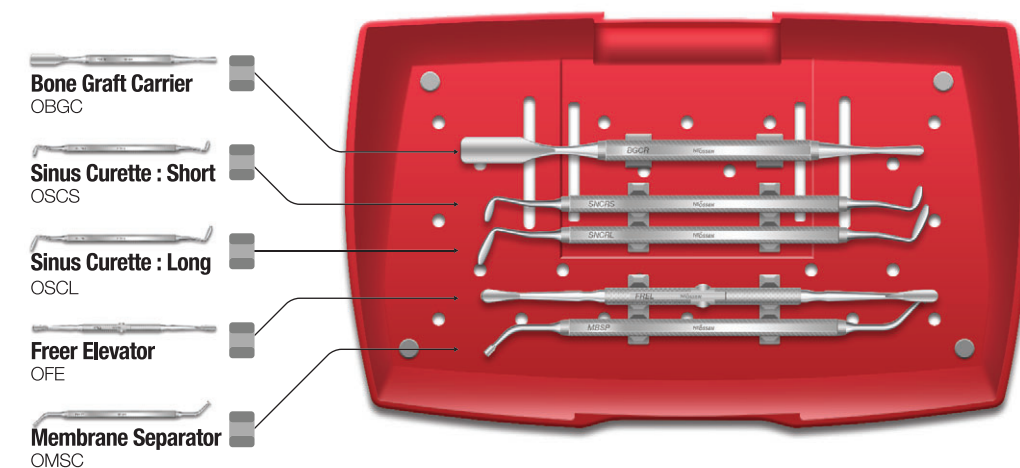

● Components

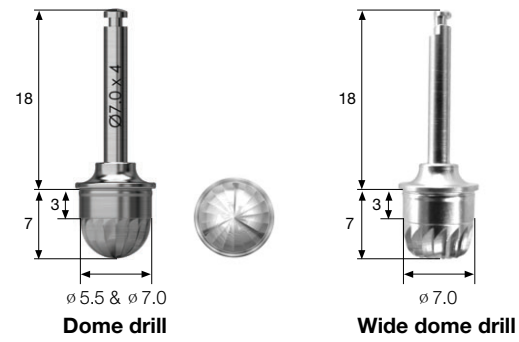

- **Dome Drill**
  - Creates window while collecting autogenous bone
  - Macro and Micro cutting blades offer excellent cutting
  - Cutting Speed: 1,200 ~ 1,500 RPM
  - Drilling depth controlled with stopper system
- **Wide dome drill**
  - Used to widen the window after using Dome drill
  - Excellent side cutting ability
  - Drilling depth controlled with stopper system
  - Cutting Speed: 1,200 ~ 1,500 RPM

\* Caution: Over drilling may cause membrane perforation.



- **Core drill**
  - Creates window while creating bone lid to minimize direct contact
  - Drill design follows the successful design concept of CAS drills
  - Cutting Speed: 1,200 ~ 1,500 RPM
  - Drilling depth controlled with stopper system

\* Caution: Over drilling may cause membrane perforation.

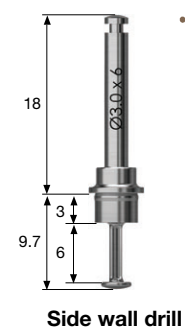

- **Side wall drill**
  - Enlarges the window after using Dome drill
  - Cutting Speed: 1,500 RPM
  - Recommended to use cutting edge 1mm from the bottom.

• Can be used with CAS Kit stoppers.

CAS-KIT Stopper(mm)	Lateral Wall Height (H:mm)	Side wall drill + CAS-KIT Stopper
12	5	
11	4	
10	3	
9	2	
8	1	

● Clinical indication and Case

1) Dome drill, Side wall drill for widening the window

by Dr. D.H. Lee

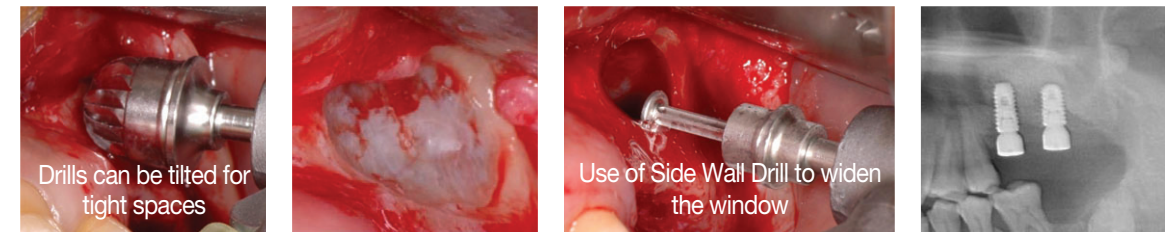

2) Dome drill with stopper

by Dr.Y.S. Cho



3) Overlapped drilling to create enlarged window

by Dr.Y.S. Cho

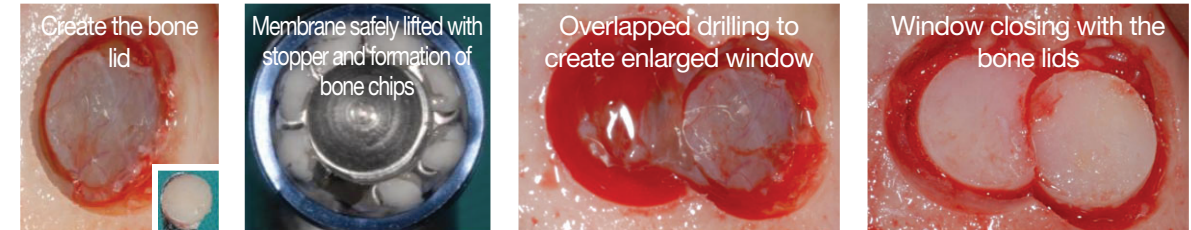

4) Combined use of Core Drill and CAS Drill

by Dr. M.S. Kim

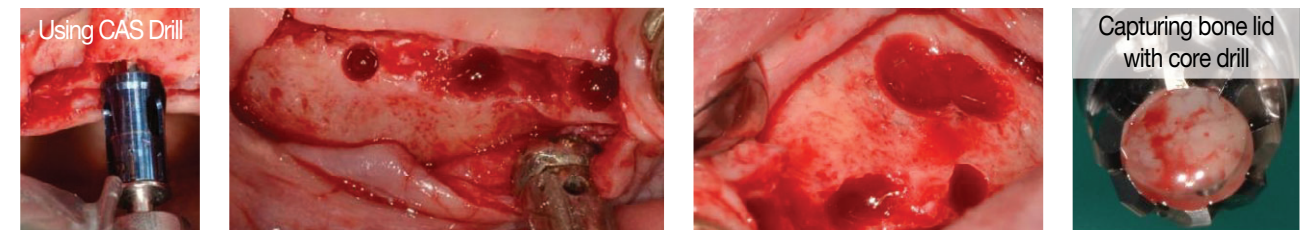

5) Combined use of Core Drill and Hydraulic Lifter from CAS Kit

by Dr. K.D. Jeong

